



**Viabizzuno** progettiamo la luce

**istruzioni di montaggio**  
**installing instructions**  
**Gebrauchsanweisung**  
**instructions de montage**  
**instrucciones de montaje**

**m1 micro**  
cassaforma scomparsa totale

- IT Viabizzuno si riserva il diritto di apportare ai propri modelli, senza nessun preavviso, qualsiasi modifica ritenga opportuna. le nostre idee e i nostri apparecchi sono depositati e coperti da brevetti internazionali. uomo avvisato, mezzo salvato.**
- EN Viabizzuno reserves the right to introduce any changes to its own models, without prior notice. our ideas and our lighting fittings are registered and covered by international patents. forewarned is forearmed.**
- DE Viabizzuno bahält sich das Recht vor jederzeit und ohne Ankündigung die technischen Daten der im Katalog abgebildetem Produkte zu ändern. unsere Ideen und unsere Beleuchtungskörper sind eingetragen und international patentiert. wer gewarnt ist, ist halb gerettet.**
- FR Viabizzuno se réserve le droit d'apporter une quelconque modification aux produits sans préavis. nos idées et nos corps d'illumination sont déposés et couverts de brevets internationales. un homme averti en vaut deux.**
- ES Viabizzuno se reserva el derecho de aportar a sus modelos, sin ningùn preavviso, cualquier modificación que considere oportuna. nuestros diseños y nuestros aparatos están todos provistos y cubiertos por patentes internacionales. el que avisa no es traidor.**

- IT **garanzia:** la presente garanzia è valida 24 mesi se timbrata e datata dal rivenditore autorizzato Viabizzuno. il periodo di garanzia è di 2 anni a partire dalla data della timbratura e decade in caso di uso improprio, manomissione o cancellatura della data, perdita o illeggibilità del presente libretto di istruzioni.
- EN **warranty:** the warranty covers 24 months if stamped and dated by the authorised Viabizzuno dealer. the 24 months warranty shall no apply in case of wrong use, altered or deleted date, or if this instructions booklet gets lost or becomes unreadable.
- DE **garantie:** Die Garantie gilt 24 Monate nur, wenn sie von dem zugelassenen Verkäufer Viabizzuno gestempelt wird. Die Garantie gilt 2 Jahr seit dem Stempeldatum und verfällt bei unberechtigten Gebrauch, Manipulation des Datums, Verlust oder Unlesbarkeit von den Gebrauchsanweisungen.
- FR **garantie:** la durée de la garantie est de 24 mois si elle est marquée par le distributeur autorisé Viabizzuno. la garantie est valable 2 ans depuis le jour où elle a été marquée et échoit en cas d'usage impropre, alteration ou effacement de la date, e si le carnet d'instructions est perdu ou est indéchiffrable.
- ES **garantía:** esta garantía es válida por 24 meses sólo si está datada y sellada por el revendedor autorizado Viabizzuno. el período de garantía es de 2 años a partir de la fecha del sello, y decae en caso de empleo impropio, alteración o borrado de la fecha, pérdida o ilegibilidad del presente manual de instrucciones.

- IT **avvertenze:** all'atto dell'installazione, ed ogni volta che si interviene sulla lampada, assicurarsi che sia stata tolta la tensione di alimentazione. le operazioni di installazione e collegamento alla rete elettrica devono essere effettuate esclusivamente da personale qualificato.  
è necessario attendere 5 minuti dallo spegnimento dell'apparecchio di illuminazione per procedere con la sostituzione di sorgenti luminose, ottiche e diffusori.
- EN **warning:** when installing fixture and during upkeep make sure that the mains voltage is off. the installation and connection operations to power mains should be done by skilled personnel only. before replacing the light sources, optics and diffusers, wait 5 minutes after switching off the light fitting.
- DE **hinweise:** Während der Installation und bei allen nachfolgenden Arbeiten auf der Lampe sollte sichergestellt werden, daß die Versorgungsspannung vorher abgenommen wurde. Die Arbeiten zur Installation und zum Anschluss an das Stromnetz sind von Fachpersonal durchzuführen. Nach dem Abschalten des Beleuchtungskörpers muss 5 Minuten abgewartet werden, bevor Lichtquellen, Optiken und Lampenschirme ausgetauscht werden
- FR **avertissements:** lors de l'installation et à chaque fois que l'on fait un entretien sur la lampe, s'assurer que la tension d'alimentation ait été coupée. les opérations d'installation et de branchement au réseau électrique doivent être effectuées par un personnel qualifié. après avoir éteint le luminaire, il est nécessaire d'attendre 5 minutes avant de procéder au changement de sources lumineuses, optiques et diffuseurs.
- ES **advertencia:** durante la instalación, y cada ve que se interviene sobre la lámpara, asegurarse que la alimentación haya sido desconectada. las operaciones de instalación y conexión a la red eléctrica tienen que ser efectuadas exclusivamente por personal cualificado. después de apagar el cuerpo iluminante, es necesario esperar 5 minutos para cambiar las fuentes luminosas, las ópticas y los difusores.

- IT **attenzione:** la sicurezza dell'apparecchio è garantita solo rispettando queste istruzioni sia in fase di installazione che di impiego.
- EN **warning:** fitting safety is only guaranteed if the following instructions are strictly observed both during installation and use.
- DE **achtung:** Für die Sicherheit des Geräts kann nur dann die Garantie übernommen werden, wenn die in den vorliegenden Anweisungen enthaltenen Hinweise sowohl bei der Installation als auch beim Betrieb beachtet werden.
- FR **attention:** la sécurité de l'appareil n'est assurée que lorsque les consignes portées sont respectées, tant lors de l'installation que durant l'utilisation de l'appareil.
- ES **atención:** la seguridad del aparato está garantizada sólo si se respetan estas instrucciones durante la fase de instalación y de empleo.

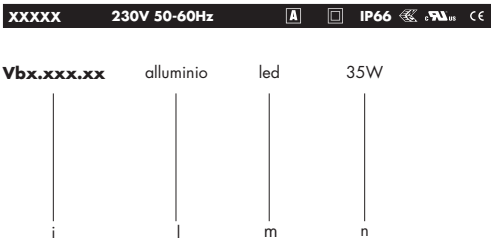
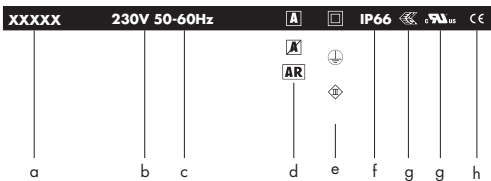

**componenti. components.** **IK10** **CE**

**accessori. accessories.** **IK10** **CE**

a	nome apparecchio di illuminazione. lighting system name
b	tensione di alimentazione. supply rating (Volt)
c	frequenza di alimentazione. supply frequency (Hertz)
d	<b>A</b> alimentatore incluso. power supply included. <b>A</b> alimentatore escluso. power supply excluded. <b>AR</b> alimentatore incluso remoto. remote power supply.
e	classe di isolamento. insulation class
f	grado di protezione. protection rating
g	marchio di certificazione. certification for safety and quality standards
h	conforme alle direttive europee produced in compliance with EC directives
i	codice. code.
l	finitura. colours and finish.
m	sorgente luminosa. light source.
n	potenza lampadina (Watt). lamp wattage (Watt).

componenti - identifica tutti gli elementi indispensabili per la corretta funzionalità e installazione del apparecchio di illuminazione

components - includes all items that are essential to the correct operation and installation of the light system

accessori - si riferisce alle ulteriori parti installabili sull'apparecchio di illuminazione

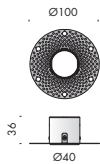

accessories - refers to items that can be added to the fitting

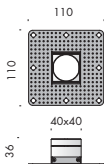

**cassaforma scomparsa totale 40. fully concealed formwork.**   

**Vb6.605.90** argento  
silver  
Silber  
argent  
plate



**cassaforma scomparsa totale 40x40. fully concealed formwork.**   

**Vb6.605.91** argento  
silver  
Silber  
argent  
plate



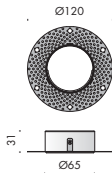

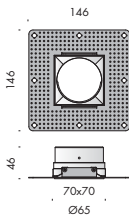

**cassaforma scomparsa totale 65. fully concealed formwork.**   

**Vb6.605.92** argento  
silver  
Silber  
argent  
plate



**cassaforma scomparsa totale 70x70. fully concealed formwork.**   

**Vb6.605.93** my bianco  
**Vb6.605.94** argento hacca  
**Vb6.605.95** marrone mn  
**Vb6.605.96** ottopo ap-s

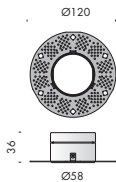

**cassaforma scomparsa totale 58. fully concealed formwork.**   

**Vb6.606.90** argento  
silver  
Silber  
argent  
plate

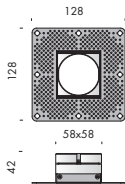

**cassaforma scomparsa totale 58x58. fully concealed formwork.**   

**Vb6.606.91** argento  
silver  
Silber  
argent  
plate

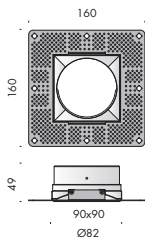
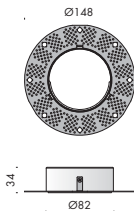

**cassaforma scomparsa totale 82. fully concealed formwork.**   

**Vb6.606.92** argento  
silver  
Silber  
argent  
plate

**cassaforma scomparsa totale 90x90. fully concealed formwork.**   

**Vb6.606.93** my bianco  
**Vb6.606.94** argento hacca  
**Vb6.606.95** marrone mn  
**Vb6.606.96** ottope ap-s

cassaforma scomparsa totale 40 + m1 micro scomparsa totale fisso 40  
fully concealed formwork 40 + m1 micro scomparsa totale fisso 40

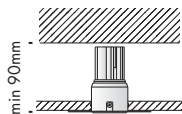

cassaforma scomparsa totale 40x40 + m1 micro scomparsa totale fisso 40x40  
fully concealed formwork 40x40 + m1 micro scomparsa totale fisso 40x40



cassaforma scomparsa totale 65 + m1 micro scomparsa totale orientabile 65  
fully concealed formwork 65 + m1 micro scomparsa totale fisso 65

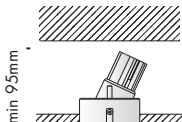

cassaforma scomparsa totale 70x70 + m1 micro scomparsa totale orientabile 65  
fully concealed formwork 70x70 + m1 micro scomparsa totale fisso 65

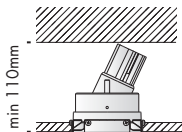

cassaforma scomparsa totale 58 + m1 micro scomparsa totale fisso 58  
fully concealed formwork 58 + m1 micro scomparsa totale fisso 58

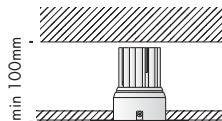

cassaforma scomparsa totale 58x58 + m1 micro scomparsa totale fisso 58x58  
fully concealed formwork 58x58 + m1 micro scomparsa totale fisso 58x58

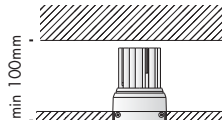

cassaforma scomparsa totale 82 + m1 micro scomparsa totale orientabile 82  
fully concealed formwork 82 + m1 micro scomparsa totale fisso 82

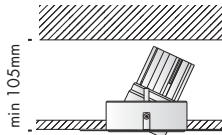

cassaforma scomparsa totale 90x90 + m1 micro scomparsa totale orientabile 82  
fully concealed formwork 90x90 + m1 micro scomparsa totale fisso 82

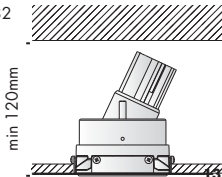

1.

Ø50



Ø70

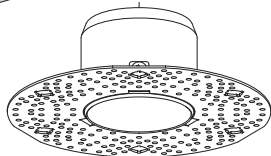

Vb6.605.90

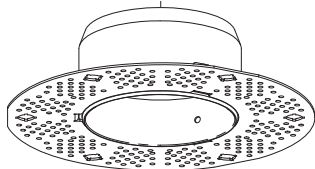

Vb6.606.90

Ø76

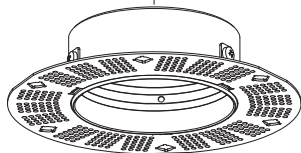
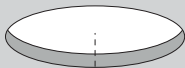

Vb6.605.92

Ø96

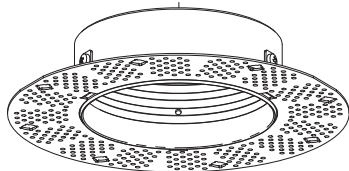
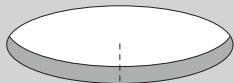

Vb6.606.92

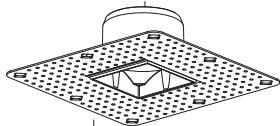
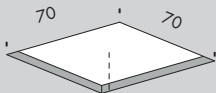
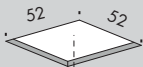

Vb6.605.91

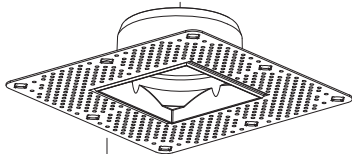

Vb6.606.91



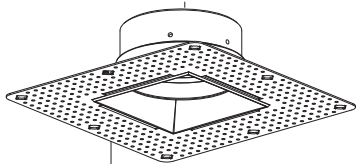
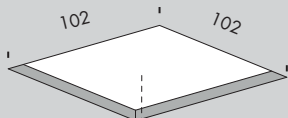
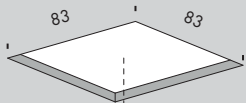

Vb6.605.93  
Vb6.605.94  
Vb6.605.95  
Vb6.605.96

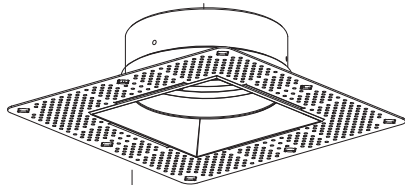

Vb6.606.93  
Vb6.606.94  
Vb6.606.95  
Vb6.606.96

2.

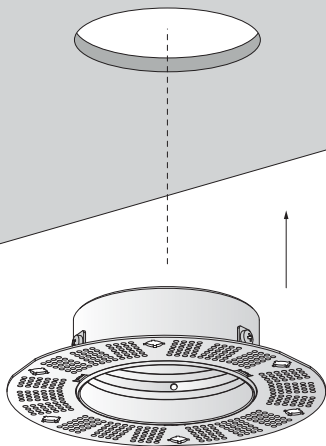

3.

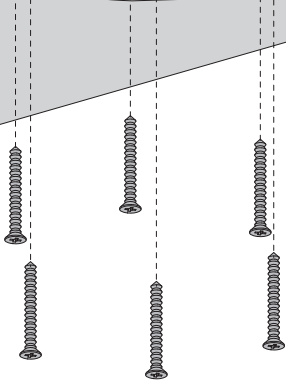
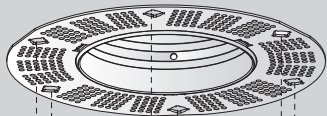

4.

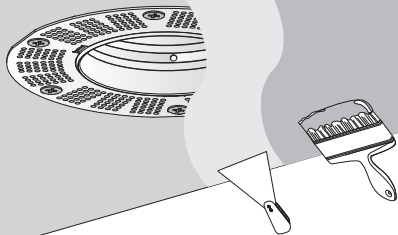

- IT stuccare, rasare e verniciare.  
EN fill, skim and decorate.  
DE verspachteln, abschaben und streichen.  
FR stuquer, raser et peindre.  
ES enmasillar, pulir y pintar.

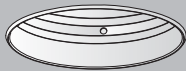



- IT **smaltimento dell'apparecchio:** a fine vita l'apparecchio di illuminazione è un rifiuto che rientra nella categoria RAEE (Rifiuto di Apparecchiatura Elettrica ed Elettronica), pertanto non deve essere smaltito come un rifiuto municipale misto ed è responsabilità dell'utente smaltirlo correttamente per evitare danni all'ambiente, alle persone e agli animali, ed evitare lo spreco di materiali riciclabili. è possibile consegnare il vecchio apparecchio al venditore nel momento in cui si acquista un nuovo apparecchio di illuminazione, oppure portare l'apparecchio nelle aree pubbliche di raccolta predisposte dalle amministrazioni comunali, o depositarlo negli appositi contenitori. per lo smaltimento delle batterie, occorre attenersi alle normative vigenti relative alla raccolta differenziata e al riciclaggio.
- EN **equipment disposal:** at the end of its life cycle, the light fitting should be considered as a Weee (Waste of electrical and electronic equipment) category waste, therefore it should be disposed of not as mixed municipal waste, but properly in order to avoid damages to the environment, people and animals, and to avoid any waste of recyclable materials. this a responsibility of the user. when ordering a new light fitting, the customer may give back his/her old one to the seller, or bring it to the public collection sites arranged by the municipal authorities, or simply put it in special collection containers. for the battery disposal, the laws concerning the sorted waste collection and recycling have to be followed.
- DE **entsorgung des geräts:** Am Ende der Lebensdauer ist das Beleuchtungsgerät als Elektro- und Elektronik-Altgerät (WEEE) zu betrachten und darf daher nicht als Hausmüll entsorgt werden. Die korrekte Entsorgung liegt in der Verantwortung des Benutzers, um Umwelt-, Tier- und Personenschäden sowie die Vergeudung recycelbarer Materialien zu vermeiden. Das ausgediente Gerät kann beim Kauf eines neuen Beleuchtungsgeräts beim Händler abgegeben oder zu einer öffentlichen Sammelstelle der Gemeindeverwaltung gebracht bzw. in den dafür vorgesehenen Behältern deponiert werden. Die Entsorgung von Batterien muss aufgrund der einschlägigen Vorschriften für die getrennte Abfallsammlung und das Recycling erfolgen

- FR **élimination de l'appareil:** au terme de sa durée de vie, l'appareil d'éclairage est un déchet qui rentre dans la catégorie DEEE (Déchets d'Équipements Électriques et Électroniques), il ne doit donc pas être éliminé comme un déchet municipal mixte et il incombe à l'utilisateur de l'éliminer correctement pour éviter tout dommage à l'environnement, aux personnes et aux animaux, et éviter le gaspillage de matériaux recyclables. il est possible de remettre le vieil appareil au vendeur lorsque l'on achète un nouvel appareil d'éclairage, ou de porter l'appareil dans les aires publiques de collecte prévues par les administrations communales, ou de le déposer dans les contenants prévus à cet effet. pour l'élimination des piles/batteries, veiller au respect des normes en vigueur relatives à la collecte sélective et au recyclage.
- ES **eliminación del aparato:** al final de su vida, el aparato de iluminación es un residuo incluido en la categoría RAEE (Residuo de Aparatos Eléctricos y Electrónicos), por lo tanto no debe eliminarse como residuo urbano mixto y es responsabilidad del usuario su correcta eliminación para evitar daños al medio ambiente, a las personas y a los animales, y para evitar el derroche de materiales reciclables. el aparato usado puede entregarse al vendedor en el momento en que se compra uno nuevo, o bien puede llevarse a una de las zonas públicas de recogida dispuestas por las administraciones municipales, o depositarlo en los contenedores al efecto. para eliminar las pilas, deben respetarse las normativas vigentes en relación con la recogida selectiva de residuos y el reciclado.

Viabizzuno strada principale della frazione di bizzuno in provincia di ravenna dove tra la casa del popolo e la parrocchia, al n°17, sono nato il ventuno luglio millenovecentocinquantacinque. da qui nasce il nome dell'azienda fondata nel millenovecentonovantaquattro rappresentata da uno spazio bianco attraversato da due linee, una verticale, rigorosa, pulita, equilibrata, ed una inclinata, irriverente nello spazio, ironica, fuori dagli schemi. distinte ma complementari proprio come le due anime rappresentate dalle due collezioni Viabizzuno. e nel punto in cui si intersecano le due linee, l'UpO, Ufficio progettazione Ombre. superficie complessiva 19.070 m<sup>2</sup>. volume complessivo 108.000 m<sup>3</sup>.



Viabizzuno is the name of the main road of the small village bizzuno located in the province of ravenna, where I was born on the 21 07 1955 at n°17, between the 'casa del popolo' and the local parish church. from here the name of the company founded in nineteen ninety-four represented by a white space intersected by two lines one vertical, well balanced, logical, clean, the other dynamic, irreverent, ironic. separate and yet complementary, just like the two different philosophies behind Viabizzuno two collections. in the intersection between the two lines, UpO, Ufficio progettazione Ombre. total area 19.070 m<sup>2</sup>. total volume 108.000 m<sup>3</sup> mn





***i nostri strumenti di lavoro*** our work tools



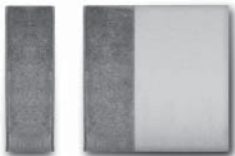

### **libro For m**

*libro di riflessioni, studi, sperimentazioni e progettazione attorno alla luce.  
tre edizioni stampate e esaurite.*

book of thoughts, studies, workshops  
and designs of light.  
three printed editions, sold out.



### **manuale**

*un manuale costituito nel tempo per  
permettere al progettista di costruire con i  
nostri corpi illuminanti il proprio linguaggio  
della luce.*

a manual created over time to allow the  
designer to create with our light fittings his/  
her own language of light.



### **Viabizzunoreport**

*il giornale semestrale che racconta il nostro modo di fare luce. per conoscere, studiare ed esplorare progetti e architetture, personaggi ed eventi e lavorare insieme con l'arte della luce.*

the half-yearly magazine that describes our way of making light. to appreciate, study and explore project and architectures, people and events and to work together with the art of light.

### **Viabizzuno unoventicinque**

*un'opera omnia. la raccolta completa dei nostri giornali che dal millenovecentonovantacinque racconta i primi ventun anni del nostro modo di fare luce, i nostri sogni e i nostri progetti. la nostra storia.*

opera omnia. the complete collection of our magazines that from ninteenninetyfive tells the first twenty-one years of our way of making light, our dreams and our projects. our history.

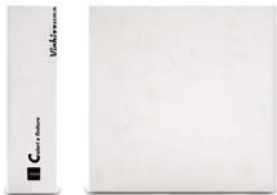

### **colori e finiture**

*la cartella che contiene la preziosità dei materiali Viabizzuno.*

the folder that contains Viabizzuno preciousness of materials.



### **dizionario maximum**

*strumento che raccoglie in ordine alfabetico tutti i nostri apparecchi di illuminazione e tutte le parole significative della filosofia, del linguaggio, del sapere Viabizzuno.*

work tool that gathers in alphabetic order all our light fixtures and all the meaningful words of Viabizzuno philosophy, language and knowledge.



### **breviario**

*la storia Viabizzuno attraverso la sua luce.  
un sunto da studiare, usare, tenere in  
tasca. una preghiera quotidiana per saper  
scegliere la luce giusta. proiettare voce del  
verbo amare.*

Viabizzuno history through its light. a  
summary to study, use, keep in your pocket.  
a daily prayer to know how select the  
correct light. to design is form of the verb  
to love.



### **vademecum**

*un piccolo volume, un compendio che  
racchiude l'identità, lo stile gli strumenti  
del nostro modo di fare luce.*

a little volume, a compendium that contains  
the identity, the style, the working tools  
of our way to enlighten.



### **Viacommerce®**

*il nostro portale dove acquistare gli apparecchi di illuminazione Viabizzuno e riceverli direttamente a casa.*  
our portal where to buy Viabizzuno light fittings and receive them directly at home.



### **[www.viabizzuno.com](http://www.viabizzuno.com)**

*il sito Viabizzuno. una pagina bianca ricca di finestre da esplorare, la pagina virtuale attraverso la quale Viabizzuno si affaccia sul mondo e racconta la sua storia, la sua luce, i suoi eventi e i suoi progetti.*

Viabizzuno website. a white page full of windows to explore, the virtual page through which Viabizzuno appears on the world and tells its own history, light, events and projects.



### **Viabizzunofilm**

*la casa cinematografica della luce.  
una raccolta di cortometraggi che narrano  
la poetica artigiana e tecnologica che sta  
alla base della costruzione di un corpo  
illuminante, la sua storia, le sue applicazioni  
e il suo immaginifico mondo luminoso.*  
the light film company. a collection of  
short films that tell the handcrafted and  
technologic poetics that is base to the  
design of light fixtures, the history, the  
applications and the fabulous lighting world.

### **libreria 3d**

*tutti i nostri corpi illuminanti in formato  
tridimensionale per poter illuminare i vostri  
disegni 3d.*  
all our lighting fixtures in 3d format in order  
to enlighten your 3d models.





### **Viabizzuno parte**

*la carta dei progettisti che dà l'opportunità a tutti i possessori di partecipare al nostro percorso progettuale, di seguirci da vicino e far parte della nostra cerchia di amici che noi riusciamo a riconoscere in tutto il mondo.*  
the designers card that enables all its possessors to participate to our design path, to follow us closely and be part of our circle of friends that we are able to recognise worldwide.



### **biblioteca della luce**

*il nostro modo di esporre la luce, di raccontarla e di farla scoprire. perché la luce va letta, interpretata, ascoltata e assaporata come un buon libro.*  
it is our way to display light, to tell and unveil it. because light must be read, interpreted, heard and tasted like a good book.



### **Viabizzuno app**

*l'applicazione Viabizzuno, uno strumento onnicomprensivo per il progettista: foto, testi, progetti, manuale, dizionario, disegni 2d e 3d, curve fotometriche. il regalo per chi cerca e progetta ogni giorno la luce giusta.*

Viabizzuno application, a comprehensive tool for the designer: pictures, texts, projects, manual, dictionary, 2d and 3d drawings, photometric curves. the gift for the ones searching and designing the correct light everyday.

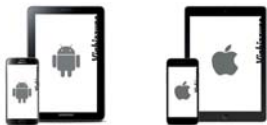

### **Viabizzuno applight**

*l'applicazione pratica e veloce per concepire la tua luce. una carrellata completa sui corpi illuminanti Viabizzuno da poter sfogliare agevolmente on line anche dal telefono. scaricala subito da app store e play store. a handy and quick application to conceive your light. a complete overview of Viabizzuno light fixtures easy to browse online also from mobiles. you can download it now from app store or play store.*

*per fecondare to fertilize  
il mondo the world  
digrandebellezza®  
e concepire and conceive  
la tua your own  
luce light  
scarica da download from  
app store  
play store*



**Viabizzuno**

**Viabizzuno** <sup>sd</sup>

10 via romagnoli

40010 bentivoglio

bologna italia

t+39 0518 908011

f+390518908089

[www.viabizzuno.com](http://www.viabizzuno.com)

[viabizzuno@viabizzuno.com](mailto:viabizzuno@viabizzuno.com)